

Product Series : GSTD	Brand : GOTREND
File Version : GSTD-PJ-SERIES-AE-V1R0	Editor : Qiuyi Wu
Established Date : 2023.11.20	Description : High Current Inductor
Latest Edit Date : 2023.11.20	Product Type : <input checked="" type="checkbox"/> Standard <input type="checkbox"/> Customize

REMINDERS

- ◆ Product information in this catalog is subject to change without notice, and is for reference only. Therefore, please contact GOTREND Technology to check for the latest information before practical application or usage of the products.
- ◆ This catalog contains only typical specifications, please contact GOTREND Technology for further details if you can not find special components or information you need in this catalogue. Please also approve our product specifications or transact the approval sheet for product specifications before ordering.
- ◆ This catalogue only applies to products purchased through GOTREND Technology or its official agencies. This catalogue does not apply to products that are purchased through other third parties.
- ◆ Please read Attention and CAUTION note (for storage, operating, rating, soldering, mounting and handling) in this catalog to ensure product proper usage.
- ◆ GOTREND Technology is not responsible for issues that occur related to the intellectual property rights or other rights of our company or a third party when you use a product listed in this catalog. GOTREND Technology do not grant license of these rights.
- ◆ Information and data provided in the brochure can and do vary in different applications, and actual performance may vary over time.
- ◆ "Delivery Specification" illustrating precautions for the specifications and safety of each product listed in this catalog is available and we strongly recommend to provide these delivery specifications with customers that use these products.
- ◆ For exporting of product in this catalog, please take note it may be a restricted item according to the "Foreign Exchange and Foreign Trade Control Law". In such cases, it is necessary to acquire export permission in accordance to this law.
- ◆ Any reproduction or extraction of the contents in this catalog is prohibited without prior permission from GOTREND Technology.
- ◆ Products listed in this catalog are intended for general electronic device usage under normal operation and use condition including telecommunication equipment, home appliances, sports equipment AV equipment, industrial machine, office equipment etc. Please take note that our products are not designed, intended or authorized for use in below mentioned applications unless explicitly agreed in writing between the parties to avoid product failure that could result in situation where personal injury or death could occur.

- (1) Aerospace/Aviation equipment
- (2) Atomic energy-related equipment
- (3) Disaster prevention/crime prevention equipment
- (4) Electric heating apparatus, burning equipment
- (5) Medical equipment
- (6) Military equipment
- (7) Power-generation control equipment
- (8) Public information-processing equipment
- (9) Safety equipment
- (10) Seabed equipment
- (11) Transportation control equipment
- (12) Transportation equipment (cars, electric trains, ships, etc.)
- (13) Other applications that are not considered general-purpose applications

- ◆ Our manufacturing sites fully compliance with requirement regarding the quality management system in the automotive industry under the IATF 16949 standard. GOTREND Technology respect individual agreements with reference to customer requirements and customer specific requirements (CSR). We will like to emphasize that only requirements mutually agreed upon will in implemented in our Quality Management System taking into consideration that IATF 16949 may appear to support the acceptance of unilateral requirements. We will only legally bind to this individually agreed upon agreement under the IATF 16949 standard.

- ◆ The product itself is a powder metallurgy product, so the structure is relatively fragile, and it should not be used for products that are easy to fall. In addition, when this product is assembled, it should avoid collision with the tool or mechanism shell.



- ◆ It is not recommended to use hot air gun for disassembling of this product. When using of hot air gun to repair other parts, please also take note that long time or high temperature exposure of this product will also damage the inductance device. If you need to use the hot air gun to disassemble the product, it is recommended to adjust the hot air gun temperature to 380 deg.C±5 deg.C. The blower head of the hot air gun should be perpendicular and at least 1cm away from the product. After heating the product to the tin material melting point, use tweezers to remove the product from the PCB.



Product Series : GSTD	Brand : GOTREND
File Version : GSTD-PJ-SERIES-AE-V1R0	Editor : Qiuyi Wu
Established Date : 2023.11.20	Description : High Current Inductor
Latest Edit Date : 2023.11.20	Product Type : <input checked="" type="checkbox"/> Standard <input type="checkbox"/> Customize

Features & Application :

- * High performance (Isat) realized by metal dust core.
- * Low loss realized with low DCR
- * Capable of corresponding high frequency
- * 100% lead (Pb) free meet RoHS standard
- * DC / DC converter for CPU in Notebook PC

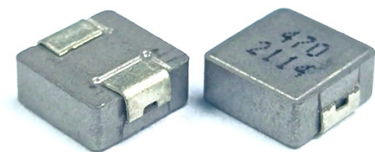

(Picture for reference only)

Part No. Example :

PN	:	GSTD	4012	P	J	-	R22	M	-	AE
-----		-----	-----	---	---		-----	---		-----
ID	:	1	2	3	4		5	6		7
1	:	GOTREND Series : GSTD								
2	:	Type Size Code : 4012 = 4.7 x 4.0 x 1.2 mm								
3	:	P = Pb free < 1000 ppm								
4	:	[E] : Material Code								
5	:	[L] Value : Inductance R22 = 0.22 uH , Ex. 6R8 = 6.8 uH								
6	:	[L] Tolerance : M = +/-20%								
7	:	[AE] : Reliability comply with AEC-Q200 standard type.								

Basic Information :

Made in	Taiwan / China
Pin Foot	SMD
Shielding	Yes
J-STD-020	MSL Level 1
RoHS	Compliant
REACH	Compliant
Halogen	Free
Automotive	AEC Q200

Operating & Storage Condition :

- * Operating Temp -40 ~ +125 °C (Including self - temperature rise)
- * Storage Temp 1. -10 ~ +45 °C , 50 ~ 60% RH (Product with taping)
2. -40 ~ +125 °C (On board)
- * Storage Life Time 6 Month (Less than 40°C and 60% RH)



Attention & Caution :

- * Keep out of Splashing water or salt water
- * Avoid Toxic Gas (Hydrogen sulfide, Sulfurous acid, Chlorine, Ammonia)
- * Avoid Vibrations or shocks which exceed the specified condition
- * Avoid Dew condense
- * Avoid Layout near the edge of PCB
- * Avoid Over flexure after SMT mounting & PCBA
- * Pin foot or SMD pad solderability: Pb free type is best within 6 months after delivery
- * Humidity sensitive , IPC/JEDEC J-STD-020 MSL if over Level 1, recommend bake 30mins@150 degree before PCBA
- * Caution for human life relative applications : PLS contact & consult with GOTREND team in design stage.



Test Condition :

- * Equipment HP4284A , HP42841A - L , Q , DCR , IDC
HP8753D Network analyzer - SRF
- * Standard Atmosphere Conditions:
Ambient Temperature 20 ± 15 °C
Humidity RH 65 ± 20%
- * If there may be any doubt on the test result ,
Measurement shall be made within the following limits:
Ambient Temperature 25 ± 5 °C
Humidity RH 75 ± 10%

Recommend IR Reflow Curve : GTX-IR-FILE001

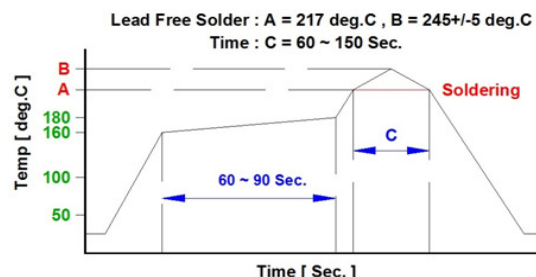





Notice : Iron Soldering , Solder < 30 Watt ,
Direct touch the terminal x 3 Sec. Max. @ 350 deg.C



Product Series : GSTD	Brand : GOTREND
File Version : GSTD-PJ-SERIES-AE-V1R0	Editor : Qiuyi Wu
Established Date : 2023.11.20	Description : High Current Inductor
Latest Edit Date : 2023.11.20	Product Type : <input checked="" type="checkbox"/> Standard <input type="checkbox"/> Customize

SMD Power Inductor - GSTD Series Type

Image	Part Name	L (mm) Typ.	W (mm) Typ.	H (mm) Typ.	Inductance Range (uH) M=+/-20%, N=+/-30%		DCR (m Ohm) Typ.	Isat (A) Typ.	Idc (A) Typ.	Page
	GSTD4012PJ	4.70	4.00	1.20	0.22	2.20	7.80 ~ 66.00	4.50 ~ 10.00	2.70 ~ 9.00	5 ~ 6
	GSTD4015PJ	4.70	4.00	1.50	0.22	2.20	6.40 ~ 56.40	4.50 ~ 11.00	3.00 ~ 9.50	7 ~ 8
	GSTD4020PJ	4.7	4.00	2.00	0.22	5.60	5.40 ~ 90.00	3.50 ~ 11.50	2.40 ~ 11.50	9 ~ 11
	GSTD6040PJ	7.60	6.50	4.00	0.22	15.00	1.10 ~ 60.00	4.30 ~ 34.00	3.60 ~ 30.00	12 ~ 14
	GSTD1050PJ	11.50	10.00	5.00	0.45	33.00	0.90 ~ 82.40	6.00 ~ 29.00	3.60 ~ 36.00	15 ~ 17

Product Series : GSTD	Brand : GOTREND
File Version : GSTD-PJ-SERIES-AE-V1R0	Editor : Qiuyi Wu
Established Date : 2023.11.20	Description : High Current Inductor
Latest Edit Date : 2023.11.20	Product Type : <input checked="" type="checkbox"/> Standard <input type="checkbox"/> Customize

GSTD4012PJ-SERIES-AE

Dimension [mm] :

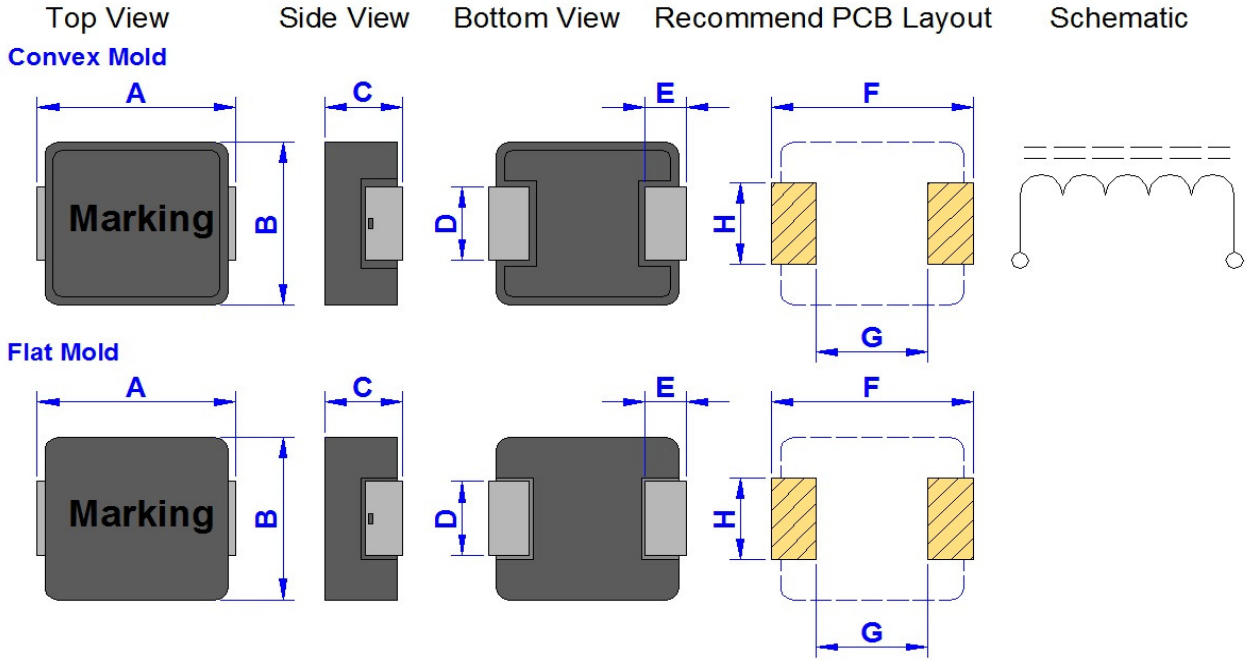

Size	A	B	C	D	E	F(Ref.)	G(Ref.)	H(Ref.)
4012PJ	4.70Max.	4.00+/-0.20	1.20Max.	BY ITEM	1.00+/-0.30	6.00	2.20	BY ITEM

Electrical Characteristics :

Part No.	Inductance (uH) +/-20%	DCR (m Ohm) Typ.	DCR (m Ohm) Max.	Isat (Amp) Typ.	Idc (Amp) Typ.	Dimension "D" (mm)	Dimension "H" (mm) Ref.
GSTD4012PJ-R22M-AE	0.22	7.80	9.30	10.00	9.00	0.6 +/- 0.1	1.5
GSTD4012PJ-R47M-AE	0.47	16.50	20.00	9.00	6.50	0.6 +/- 0.1	1.5
GSTD4012PJ-R56M-AE	0.56	22.00	25.00	8.00	5.50	0.6 +/- 0.1	1.5
GSTD4012PJ-R68M-AE	0.68	18.80	20.68	8.00	5.40	0.6 +/- 0.1	1.5
GSTD4012PJ-1R0M-AE	1.00	28.30	33.60	6.30	4.80	0.6 +/- 0.1	1.5
GSTD4012PJ-1R2M-AE	1.20	41.00	45.00	6.00	3.00	0.6 +/- 0.1	1.5
GSTD4012PJ-1R5M-AE	1.50	45.00	50.00	5.50	3.00	0.6 +/- 0.1	1.5
GSTD4012PJ-2R2M-AE	2.20	60.00	66.00	4.50	2.70	0.6 +/- 0.1	1.5

* Test Condition : @100KHz , 0.25Vrms , 25deg.C Ambient

* Idc: DC current (A) that will cause an approximate ΔT of 40°C

* Isat: DC current (A) that will cause LO to drop approximately 20%

Product Series : GSTD	Brand : GOTREND
File Version : GSTD-PJ-SERIES-AE-V1R0	Editor : Qiuyi Wu
Established Date : 2023.11.20	Description : High Current Inductor
Latest Edit Date : 2023.11.20	Product Type : <input checked="" type="checkbox"/> Standard <input type="checkbox"/> Customize

GSTD4012PJ-SERIES-AE

Current Characteristic:

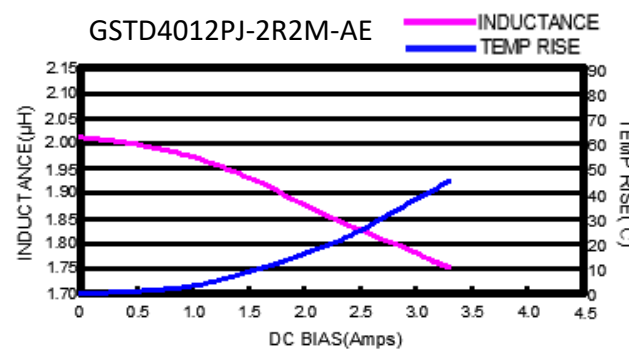
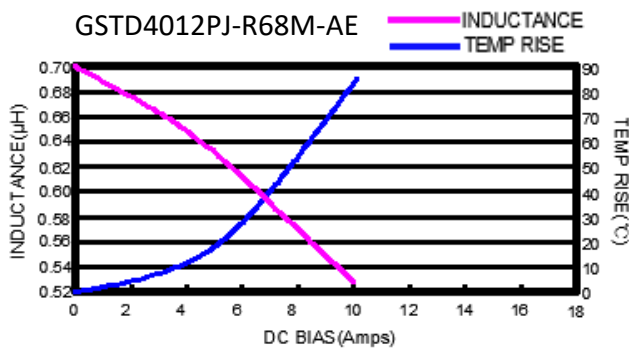
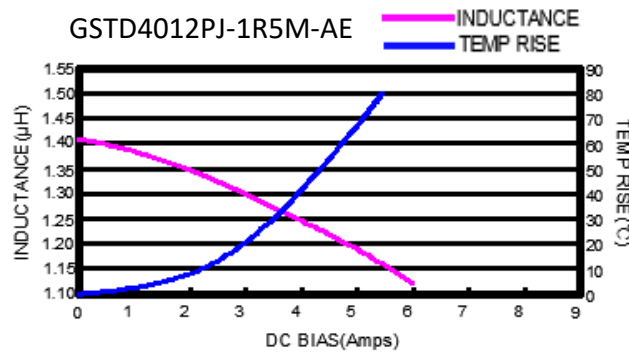
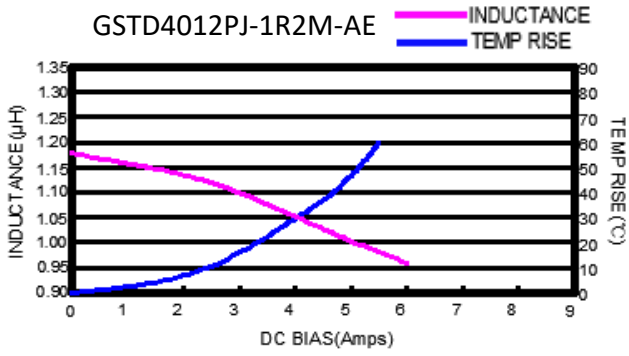
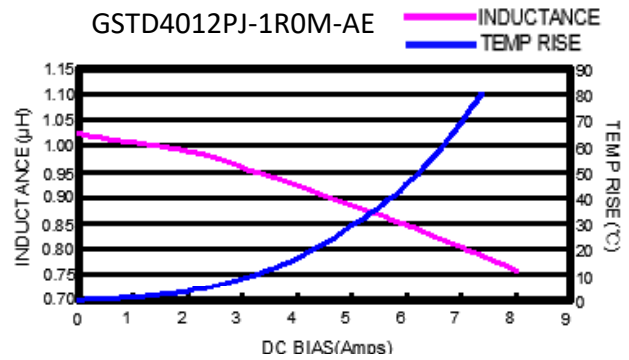
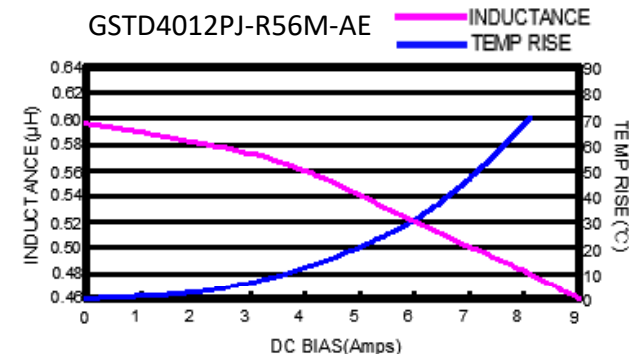
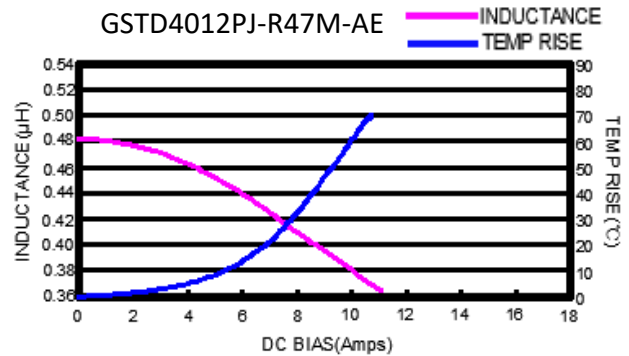
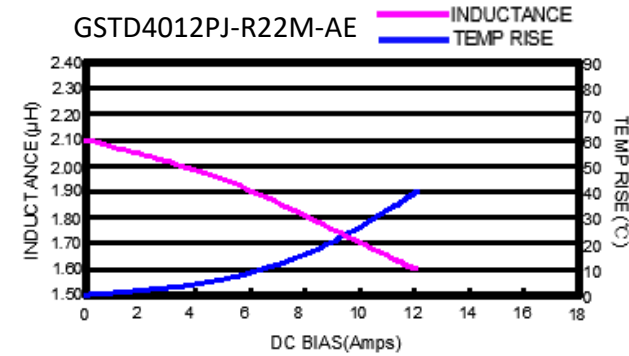

Product Series : GSTD	Brand : GOTREND
File Version : GSTD-PJ-SERIES-AE-V1R0	Editor : Qiuyi Wu
Established Date : 2023.11.20	Description : High Current Inductor
Latest Edit Date : 2023.11.20	Product Type : <input checked="" type="checkbox"/> Standard <input type="checkbox"/> Customize

GSTD4015PJ-SERIES-AE

Dimension [mm] :

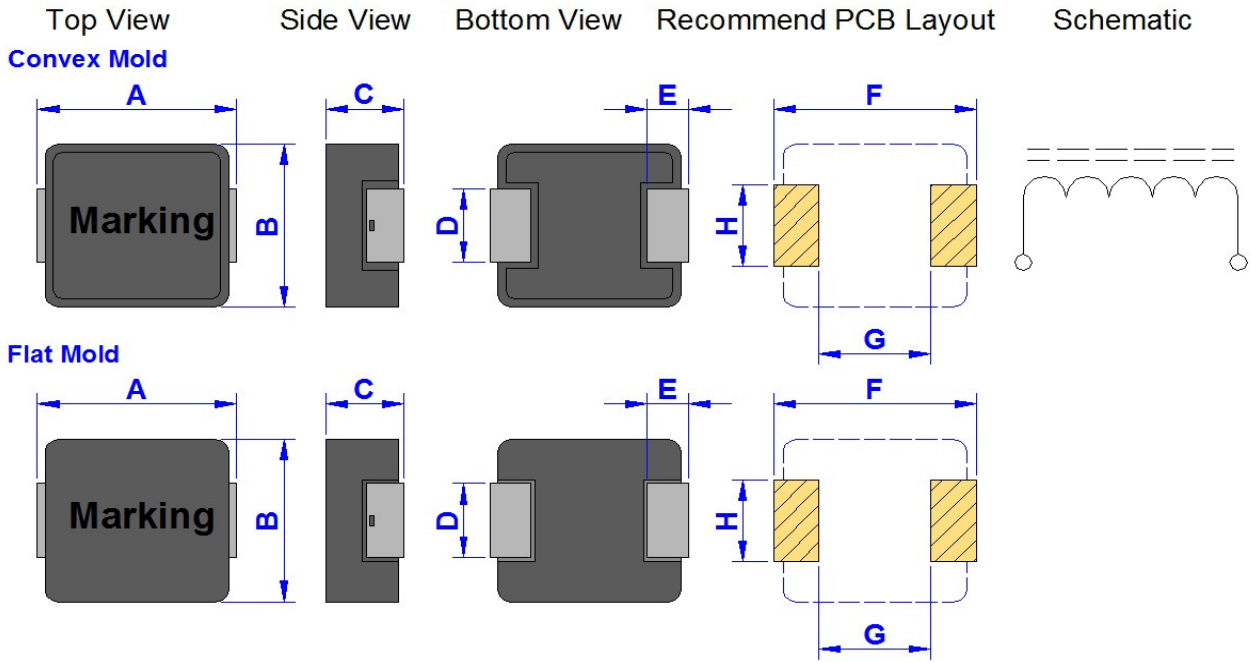

Size	A	B	C	D	E	F(Ref.)	G(Ref.)	H(Ref.)
4015PJ	4.70Max.	4.00+/-0.20	1.50Max.	BY ITEM	1.00+/-0.30	6.00	2.20	BY ITEM

Electrical Characteristics :

Part No.	Inductance (uH) +/-20%	DCR (m Ohm) Typ.	DCR (m Ohm) Max.	Isat (Amp) Typ.	Idc (Amp) Typ.	Dimension "D" (mm)	Dimension "H" (mm) Ref.
GSTD4015PJ-R22M-AE	0.22	6.40	7.60	11.00	9.50	0.6 +/- 0.1	1.5
GSTD4015PJ-R47M-AE	0.47	12.00	14.40	9.00	7.50	0.6 +/- 0.1	1.5
GSTD4015PJ-1R0M-AE	1.00	23.50	27.00	7.00	5.00	0.6 +/- 0.1	1.5
GSTD4015PJ-1R2M-AE	1.20	28.30	33.60	6.00	4.90	0.6 +/- 0.1	1.5
GSTD4015PJ-1R5M-AE	1.50	32.00	38.40	6.00	4.00	0.6 +/- 0.1	1.5
GSTD4015PJ-2R2M-AE	2.20	47.00	56.40	4.50	3.00	0.6 +/- 0.1	1.5

* Test Condition : @100KHz , 0.25Vrms , 25deg.C Ambient

* Idc: DC current (A) that will cause an approximate ΔT of 40°C

* Isat: DC current (A) that will cause LO to drop approximately 20%

Product Series : GSTD	Brand : GOTREND
File Version : GSTD-PJ-SERIES-AE-V1R0	Editor : Qiuyi Wu
Established Date : 2023.11.20	Description : High Current Inductor
Latest Edit Date : 2023.11.20	Product Type : <input checked="" type="checkbox"/> Standard <input type="checkbox"/> Customize

GSTD4015PJ-SERIES-AE

Current Characteristic:

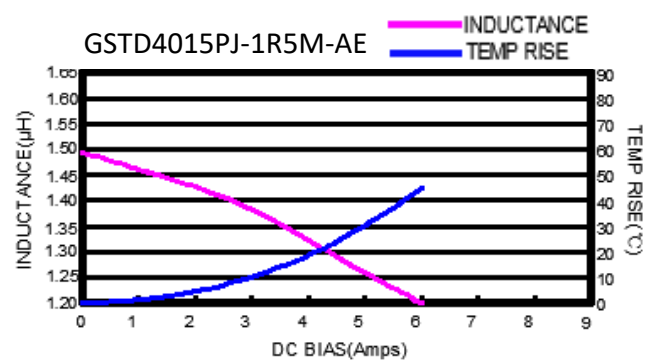
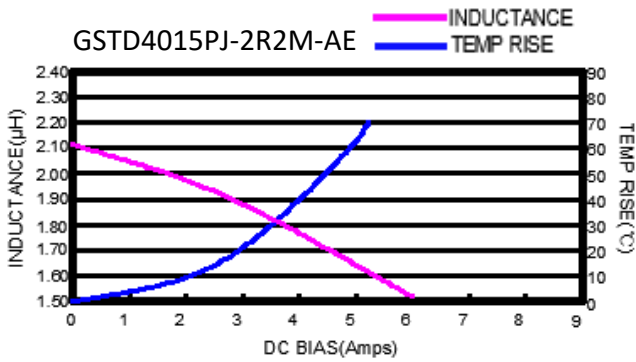
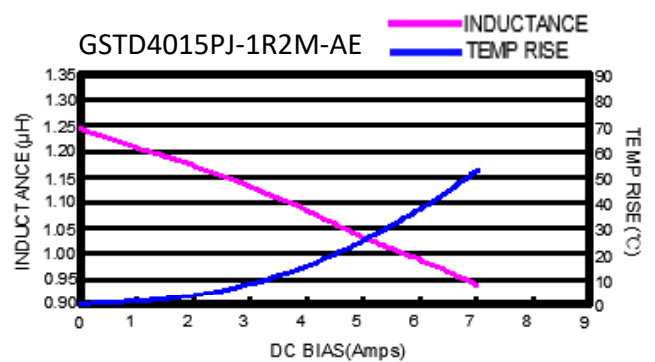
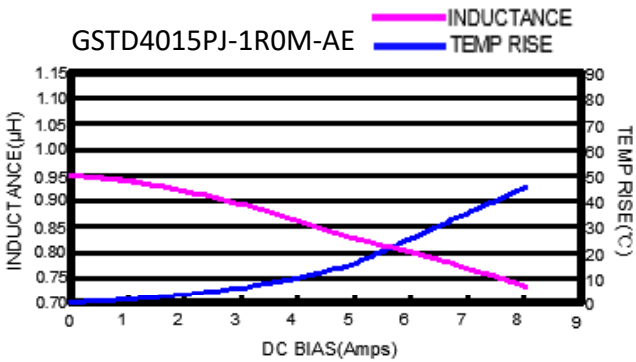
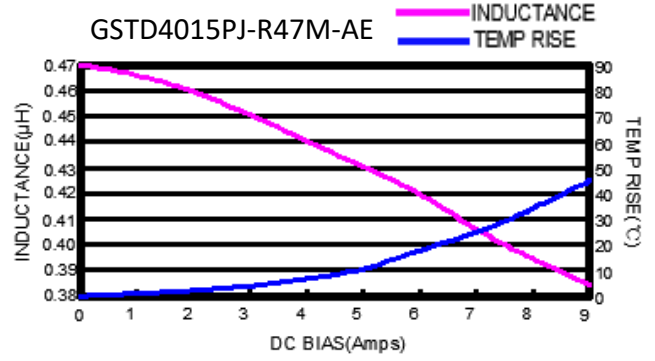
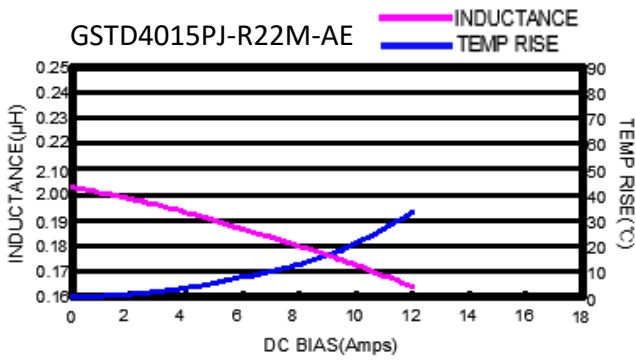

Product Series : GSTD	Brand : GOTREND
File Version : GSTD-PJ-SERIES-AE-V1R0	Editor : Qiuyi Wu
Established Date : 2023.11.20	Description : High Current Inductor
Latest Edit Date : 2023.11.20	Product Type : <input checked="" type="checkbox"/> Standard <input type="checkbox"/> Customize

GSTD4020PJ-SERIES-AE

Dimension [mm] :

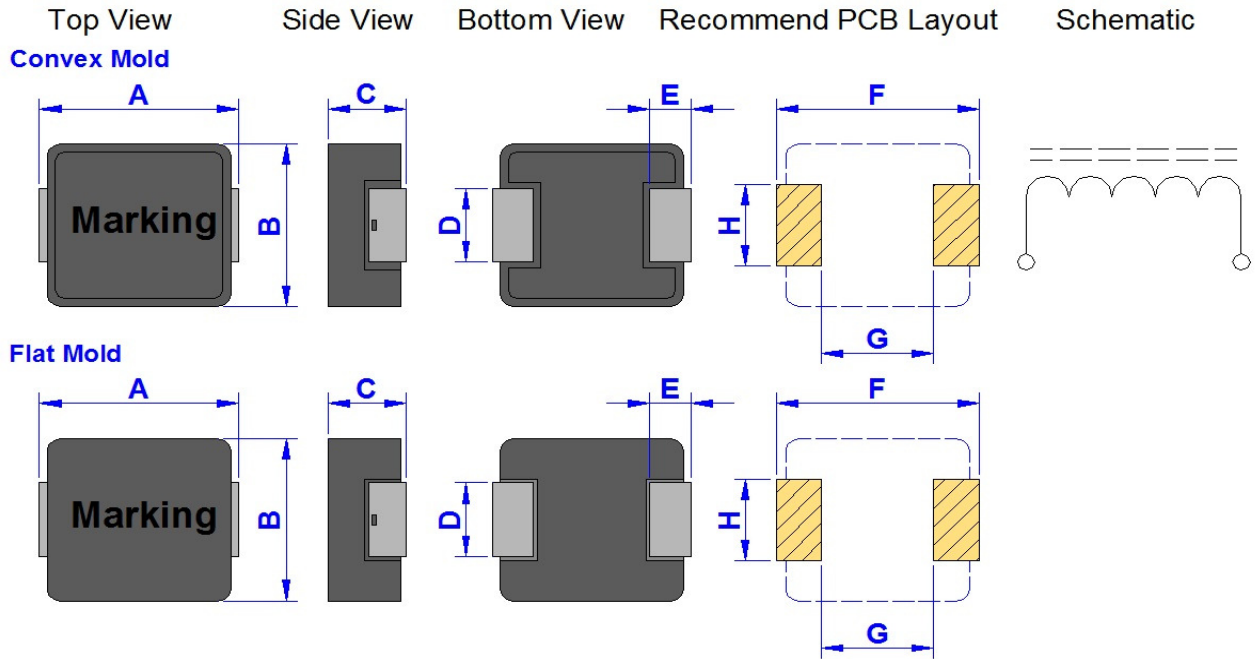

Size	A	B	C	D	E	F(Ref.)	G(Ref.)	H(Ref.)
4020PJ	4.70Max.	4.00+/-0.20	2.00Max.	BY ITEM	1.00+/-0.30	6.0	2.20	BY ITEM

Electrical Characteristics :

Part No.	Inductance (uH) +/-20%	DCR (m Ohm) Typ.	DCR (m Ohm) Max.	Isat (Amp) Typ.	Idc (Amp) Typ.	Dimension "D" (mm)	Dimension "H" (mm) Ref.
GSTD4020PJ-R22M-AE	0.22	5.40	7.00	11.50	11.50	0.6 +/- 0.1	1.5
GSTD4020PJ-R36M-AE	0.36	9.50	12.00	11.00	9.00	0.6 +/- 0.1	1.5
GSTD4020PJ-R47M-AE	0.47	10.00	12.00	10.00	7.00	0.6 +/- 0.1	1.5
GSTD4020PJ-R56M-AE	0.56	12.80	14.70	8.00	7.00	0.6 +/- 0.1	1.5
GSTD4020PJ-R68M-AE	0.68	13.50	17.00	7.00	6.30	0.6 +/- 0.1	1.5
GSTD4020PJ-R82M-AE	0.82	16.00	18.00	6.50	6.00	0.6 +/- 0.1	1.5
GSTD4020PJ-R88M-AE	0.88	16.00	18.00	6.50	6.00	0.6 +/- 0.1	1.5
GSTD4020PJ-1R0M-AE	1.00	18.00	21.50	5.00	5.00	0.6 +/- 0.1	1.5
GSTD4020PJ-1R2M-AE	1.20	19.00	22.00	5.00	5.00	0.6 +/- 0.1	1.5
GSTD4020PJ-1R5M-AE	1.50	25.40	29.00	5.00	5.00	0.6 +/- 0.1	1.5
GSTD4020PJ-2R2M-AE	2.20	33.00	40.00	5.00	3.90	0.6 +/- 0.1	1.5
GSTD4020PJ-3R3M-AE	3.30	42.00	48.00	4.30	3.30	0.6 +/- 0.1	1.5
GSTD4020PJ-4R7M-AE	4.70	68.00	75.00	4.00	2.70	0.6 +/- 0.1	1.5

* Test Condition : @100KHz , 0.25Vrms , 25deg.C Ambient

* Idc: DC current (A) that will cause an approximate ΔT of 40°C

* Isat: DC current (A) that will cause LO to drop approximately 20%

Product Series : GSTD	Brand : GOTREND
File Version : GSTD-PJ-SERIES-AE-V1R0	Editor : Qiuyi Wu
Established Date : 2023.11.20	Description : High Current Inductor
Latest Edit Date : 2023.11.20	Product Type : <input checked="" type="checkbox"/> Standard <input type="checkbox"/> Customize

GSTD4020PJ-SERIES-AE

Current Characteristic:

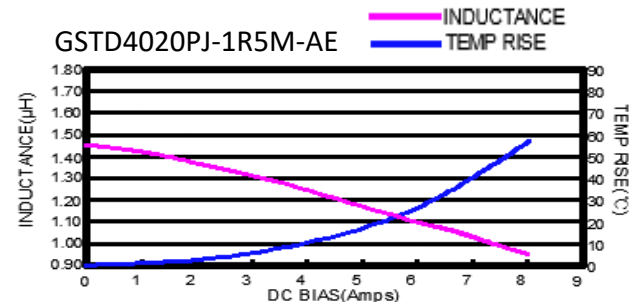
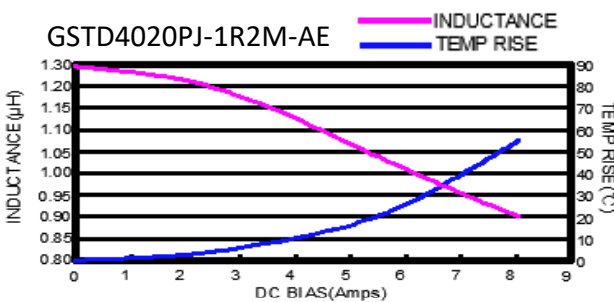
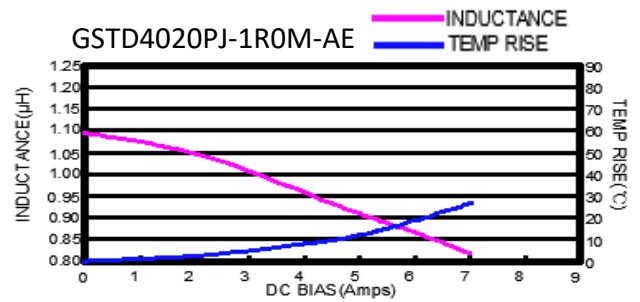
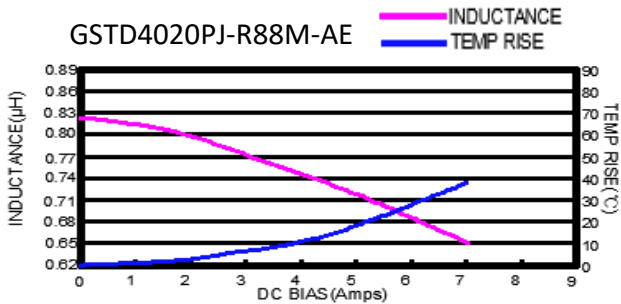
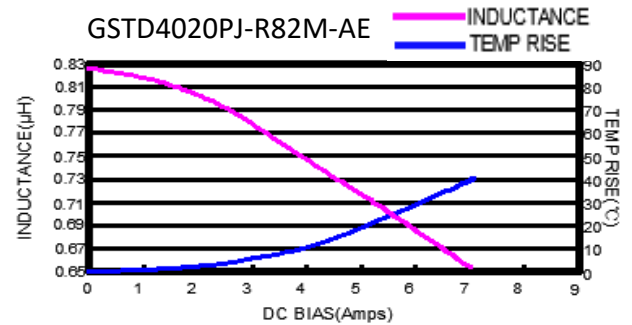
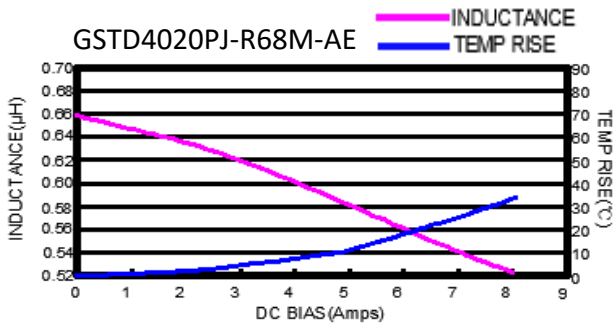
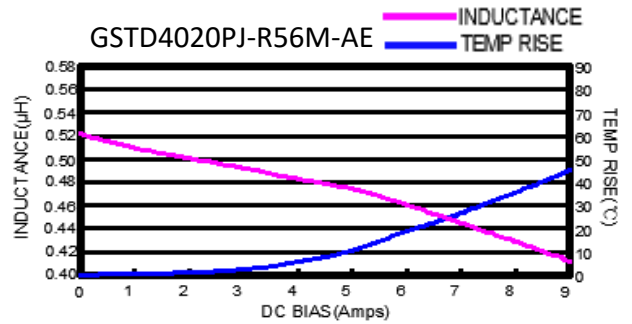
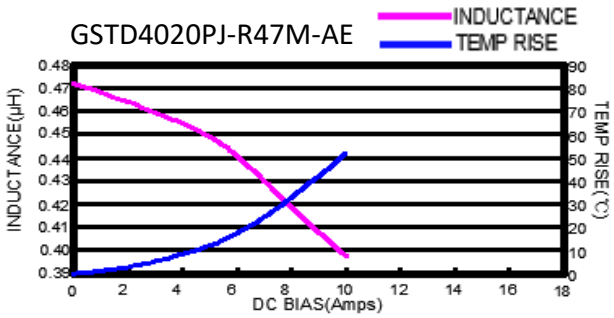
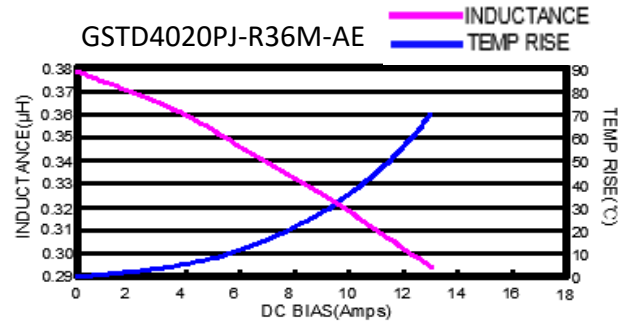
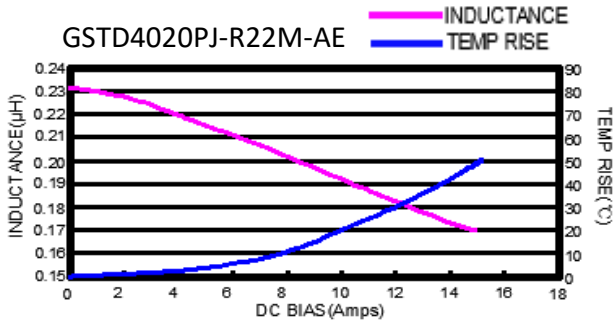

Product Series : GSTD	Brand : GOTREND
File Version : GSTD-PJ-SERIES-AE-V1R0	Editor : Qiuyi Wu
Established Date : 2023.11.20	Description : High Current Inductor
Latest Edit Date : 2023.11.20	Product Type : <input checked="" type="checkbox"/> Standard <input type="checkbox"/> Customize

GSTD4020PJ-SERIES-AE

Current Characteristic:

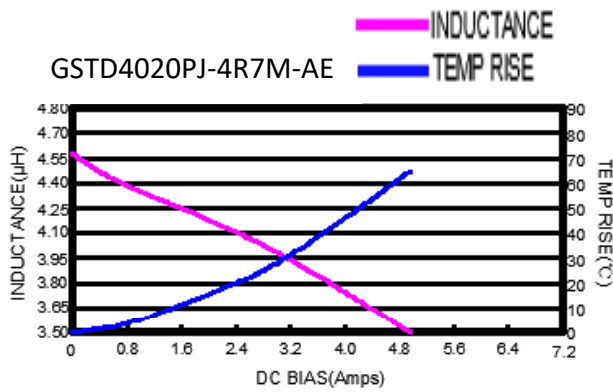
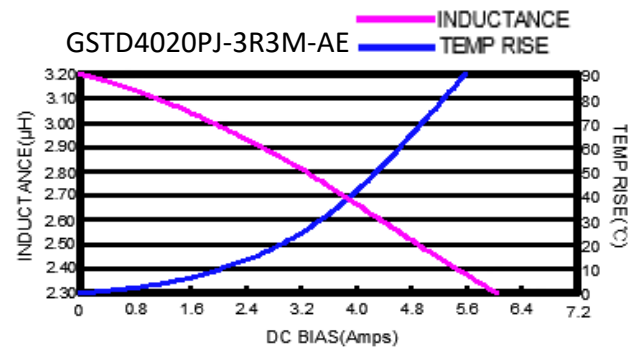
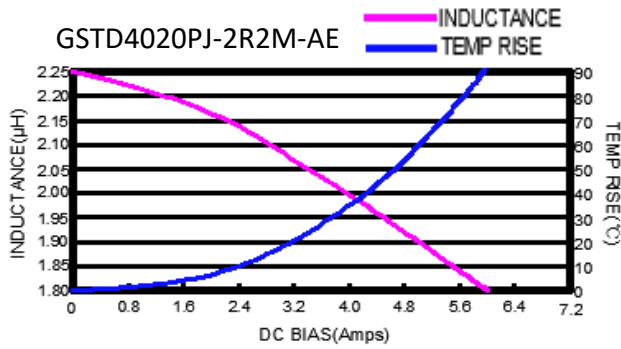

Product Series : GSTD	Brand : GOTREND
File Version : GSTD-PJ-SERIES-AE-V1R0	Editor : Qiuyi Wu
Established Date : 2023.11.20	Description : High Current Inductor
Latest Edit Date : 2023.11.20	Product Type : <input checked="" type="checkbox"/> Standard <input type="checkbox"/> Customize

GSTD6040PJ-SERIES-AE

Dimension [mm] :

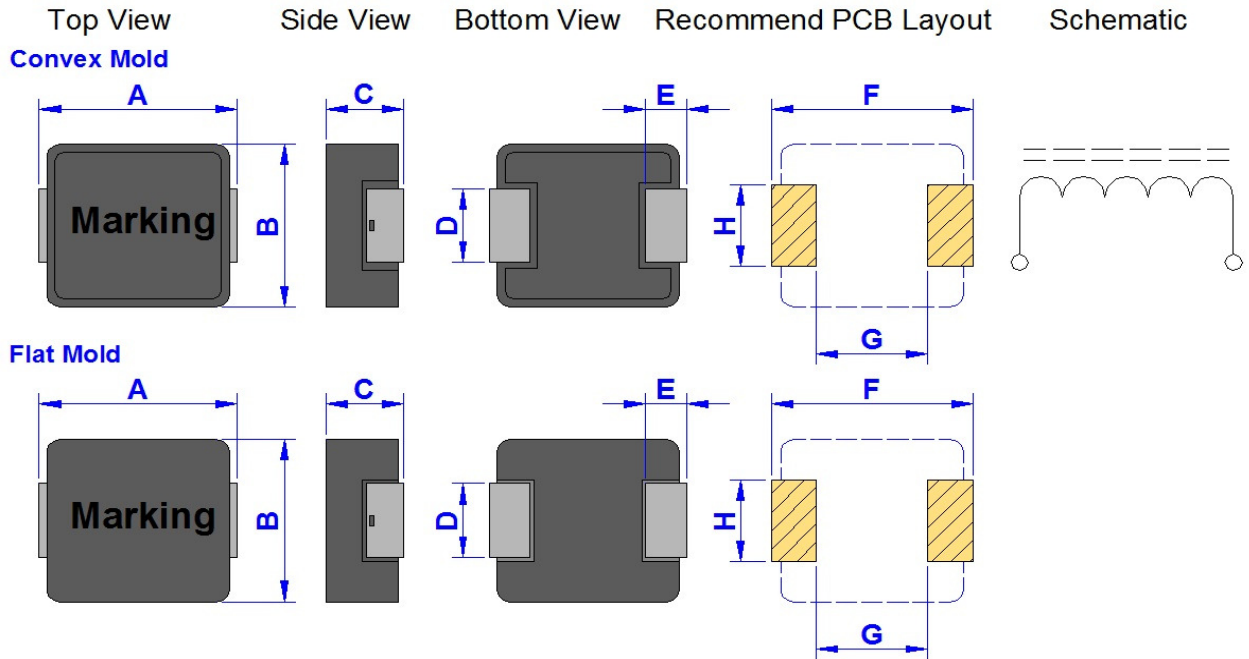

Size	A	B	C	D	E	F(Ref.)	G(Ref.)	H(Ref.)
6040PJ	7.60 Max.	6.50+/-0.20	4.00 Max.	BY ITEM	1.50+/-0.30	8.50	3.00	BY ITEM

Electrical Characteristics :

Part No.	Inductance (uH) +/-20%	DCR (m Ohm) Typ.	DCR (m Ohm) Max.	Isat (Amp) Typ.	Idc (Amp) Typ.	Dimension "D" (mm)	Dimension "H" (mm) Ref.
GSTD6040PJ-R50M-AE	0.50	2.80	3.40	21.00	20.00	1.2 +/- 0.3	2.5
GSTD6040PJ-1R1M-AE	1.10	4.60	5.50	19.00	15.30	1.2 +/- 0.3	2.5
GSTD6040PJ-1R5M-AE	1.50	8.00	10.00	13.00	11.50	1.2 +/- 0.3	2.5
GSTD6040PJ-2R2M-AE	2.20	9.80	12.00	11.00	11.00	1.2 +/- 0.3	2.5
GSTD6040PJ-3R3M-AE	3.30	12.50	16.00	10.00	10.00	1.2 +/- 0.3	2.5
GSTD6040PJ-4R7M-AE	4.70	18.40	24.00	8.00	6.70	1.2 +/- 0.3	2.5
GSTD6040PJ-5R6M-AE	5.60	21.00	29.00	8.00	6.30	1.2 +/- 0.3	2.5
GSTD6040PJ-6R8M-AE	6.80	29.00	33.00	7.00	6.00	1.2 +/- 0.3	2.5
GSTD6040PJ-8R2M-AE	8.20	34.00	39.00	5.50	5.00	1.2 +/- 0.3	2.5
GSTD6040PJ-100M-AE	10.00	42.50	45.00	5.00	4.10	1.2 +/- 0.3	2.5
GSTD6040PJ-120M-AE	12.00	46.30	53.00	5.00	4.00	1.2 +/- 0.3	2.5
GSTD6040PJ-150M-AE	15.00	57.30	60.00	4.30	3.60	1.2 +/- 0.3	2.5

* **Test Condition :** @100KHz , 0.25Vrms , 25deg.C Ambient

* **Idc:** DC current (A) that will cause an approximate ΔT of 40°C

* **Isat:** DC current (A) that will cause LO to drop approximately 20%

Product Series : GSTD	Brand : GOTREND
File Version : GSTD-PJ-SERIES-AE-V1R0	Editor : Qiuyi Wu
Established Date : 2023.11.20	Description : High Current Inductor
Latest Edit Date : 2023.11.20	Product Type : <input checked="" type="checkbox"/> Standard <input type="checkbox"/> Customize

GSTD6040PJ-SERIES-AE

Current Characteristic:

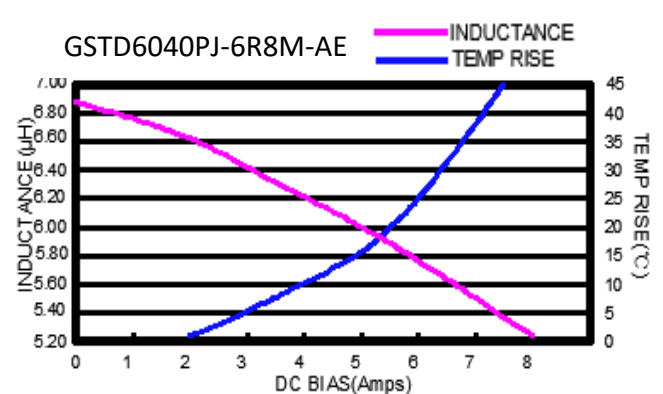
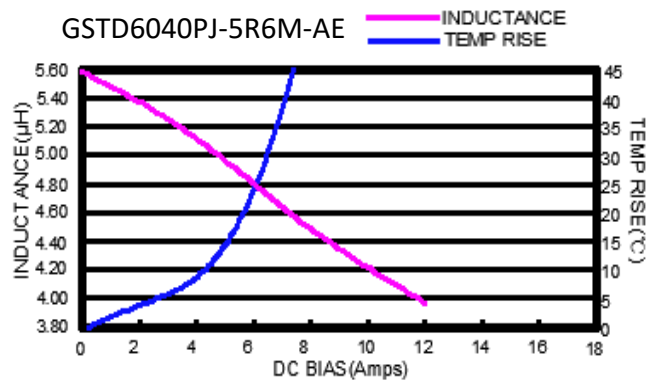
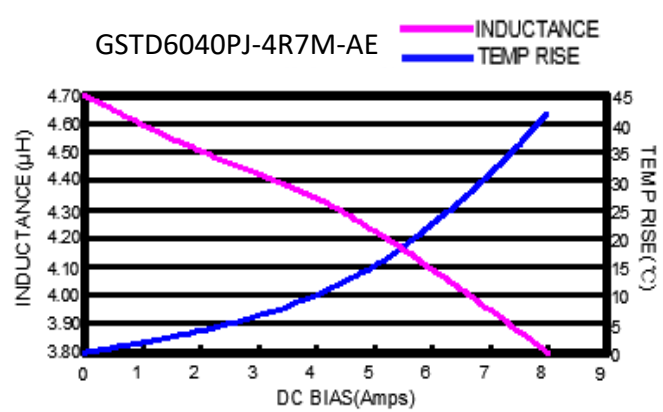
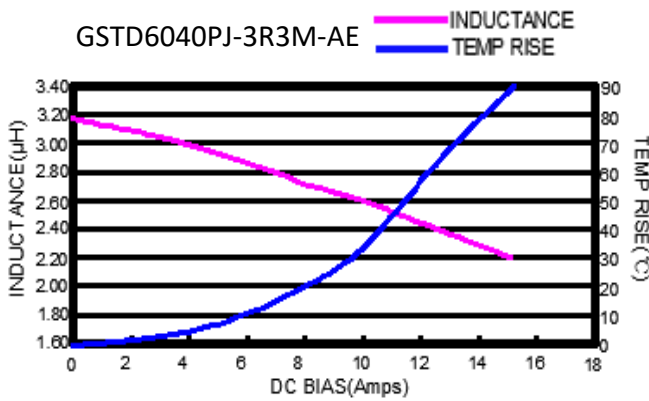
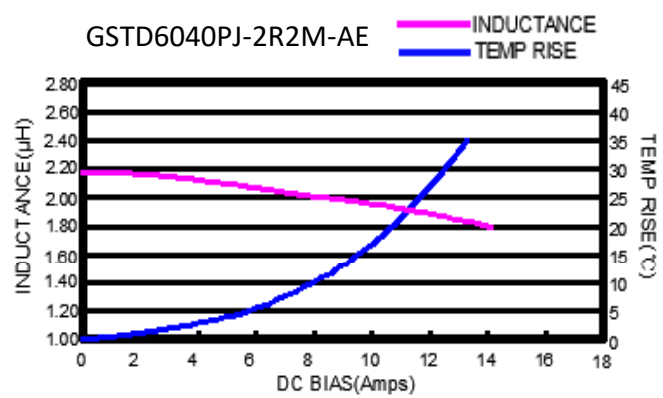
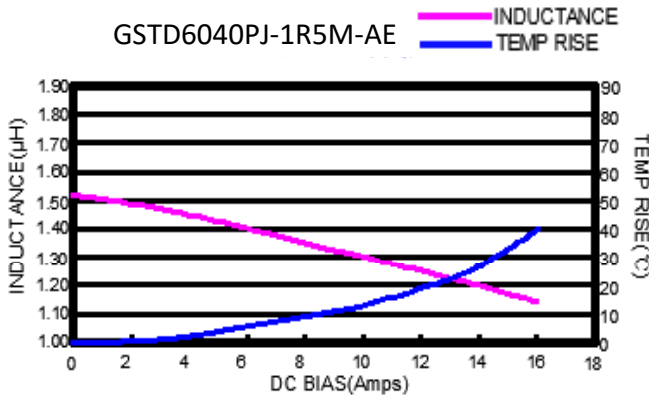
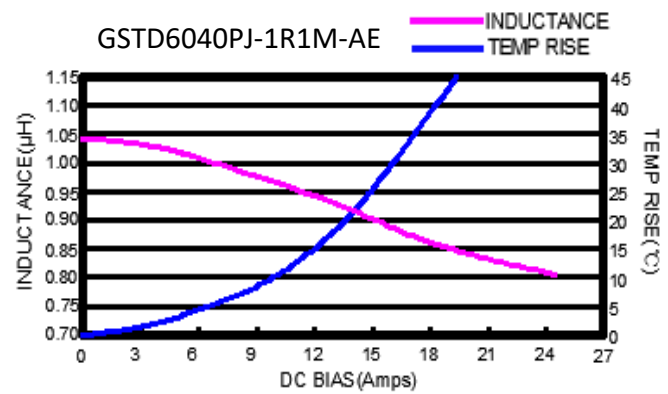
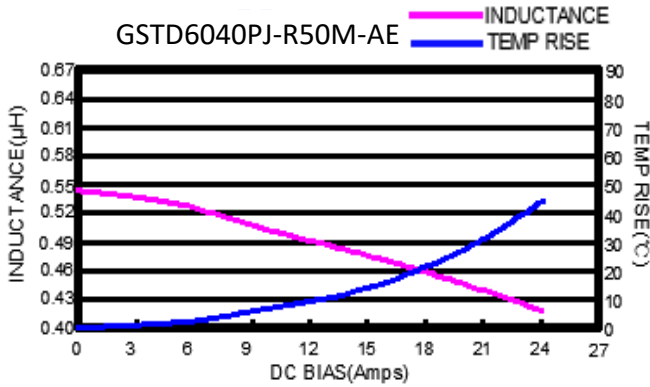

Product Series : GSTD	Brand : GOTREND
File Version : GSTD-PJ-SERIES-AE-V1R0	Editor : Qiuyi Wu
Established Date : 2023.11.20	Description : High Current Inductor
Latest Edit Date : 2023.11.20	Product Type : <input checked="" type="checkbox"/> Standard <input type="checkbox"/> Customize

GSTD6040PJ-SERIES-AE

Current Characteristic:

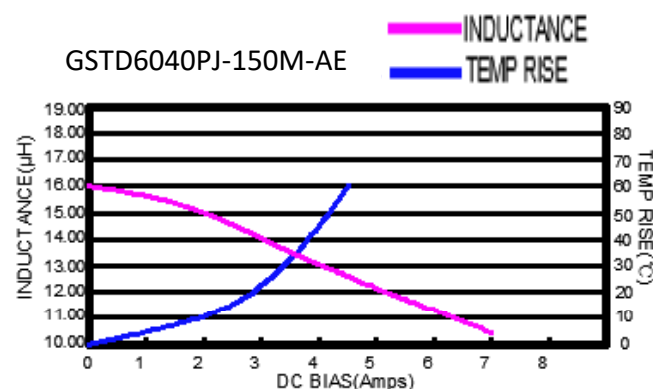
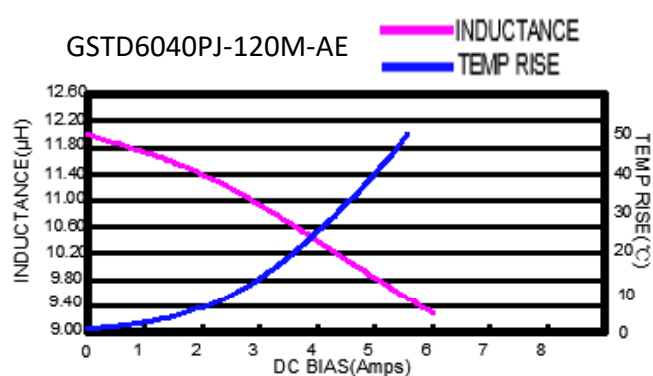
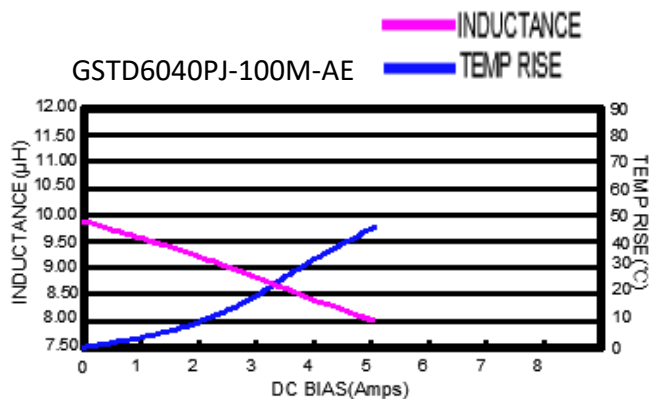
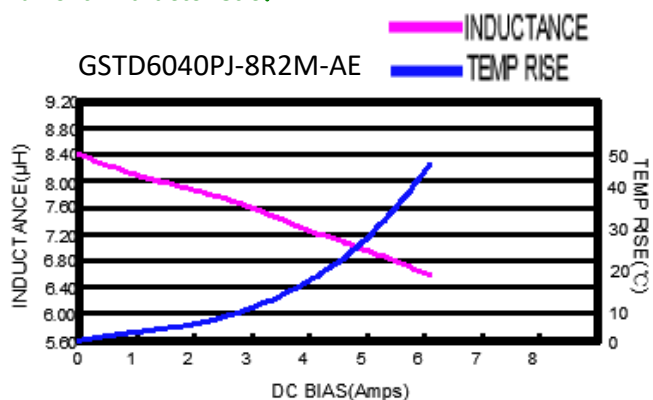

Product Series : GSTD	Brand : GOTREND
File Version : GSTD-PJ-SERIES-AE-V1R0	Editor : Qiuyi Wu
Established Date : 2023.11.20	Description : High Current Inductor
Latest Edit Date : 2023.11.20	Product Type : <input checked="" type="checkbox"/> Standard <input type="checkbox"/> Customize

GSTD1050PJ-SERIES-AE

Dimension [mm] :

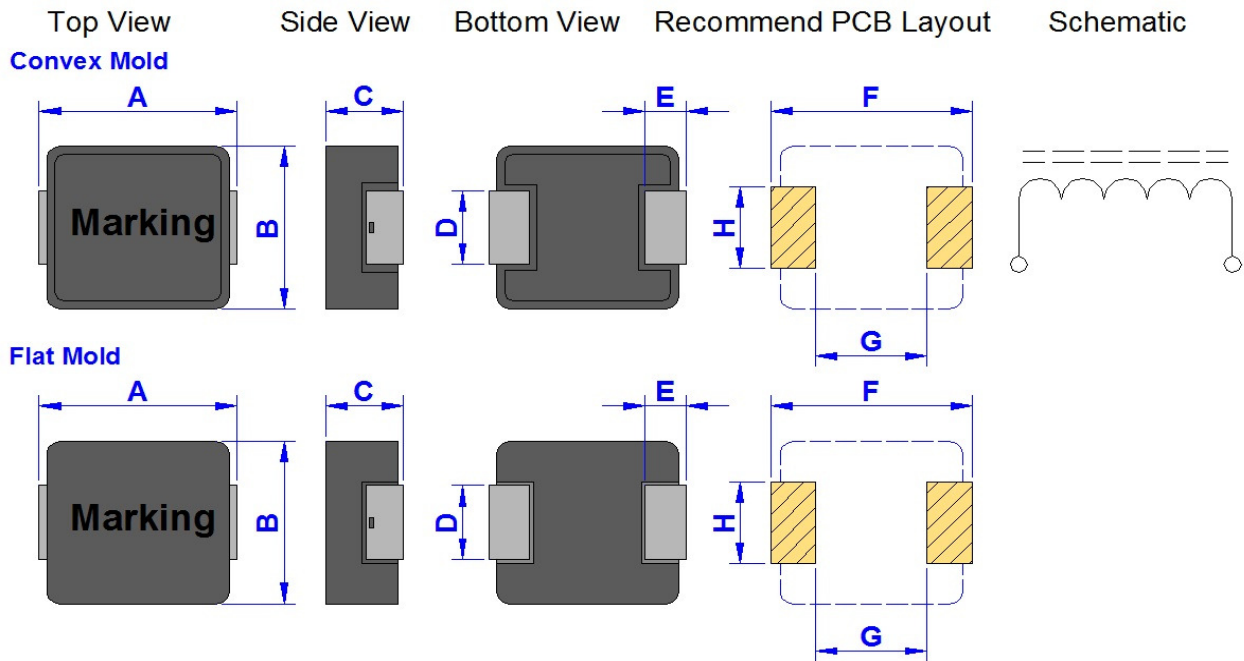

Size	A	B	C	D	E	F(Ref.)	G(Ref.)	H(Ref.)
1050PJ	11.50Max.	10.00+/-0.30	5.00Max.	BY ITEM	2.00+/-0.50	13.6	5.4	BY ITEM

Electrical Characteristics :

Part No.	Inductance (uH) +/-20%	DCR (m Ohm) Typ.	DCR (m Ohm) Max.	Isat (Amp) Typ.	Idc (Amp) Typ.	Dimension "D" (mm)	Dimension "H" (mm) Ref.
GSTD1050PJ-R45M-AE	0.45	0.90	1.10	29.00	36.00	3.0 +/- 0.5	4.1
GSTD1050PJ-R56M-AE	0.56	1.20	1.40	29.00	32.00	3.0 +/- 0.5	4.1
GSTD1050PJ-1R0M-AE	1.00	2.30	2.50	25.00	25.00	3.0 +/- 0.5	4.1
GSTD1050PJ-1R2M-AE	1.20	2.50	3.00	21.00	24.00	3.0 +/- 0.5	4.1
GSTD1050PJ-2R0M-AE	2.00	5.30	6.30	19.00	14.00	3.0 +/- 0.5	4.1
GSTD1050PJ-2R2M-AE	2.20	5.30	6.30	19.00	14.00	3.0 +/- 0.5	4.1
GSTD1050PJ-4R7M-AE	4.70	10.50	11.50	14.00	10.00	1.8 +/- 0.5	4.1
GSTD1050PJ-6R8M-AE	6.80	13.50	15.50	11.00	9.00	3.0 +/- 0.5	4.1
GSTD1050PJ-7R0M-AE	7.00	16.50	20.40	12.00	8.00	3.0 +/- 0.5	4.1
GSTD1050PJ-8R2M-AE	8.20	14.70	16.00	10.00	9.00	3.0 +/- 0.5	4.1
GSTD1050PJ-100M-AE	10.00	21.00	25.20	10.00	7.20	3.0 +/- 0.5	4.1
GSTD1050PJ-150M-AE	15.00	29.20	35.00	8.00	5.90	3.0 +/- 0.5	4.1
GSTD1050PJ-220M-AE	22.00	46.50	55.80	7.00	4.50	3.0 +/- 0.5	4.1
GSTD1050PJ-330M-AE	33.00	68.70	82.40	6.00	3.60	3.0 +/- 0.5	4.1

* Test Condition : @100KHz , 0.25Vrms , 25deg.C Ambient

* Idc: DC current (A) that will cause an approximate ΔT of 40°C

* Isat: DC current (A) that will cause LO to drop approximately 20%

Product Series : GSTD	Brand : GOTREND
File Version : GSTD-PJ-SERIES-AE-V1R0	Editor : Qiuyi Wu
Established Date : 2023.11.20	Description : High Current Inductor
Latest Edit Date : 2023.11.20	Product Type : <input checked="" type="checkbox"/> Standard <input type="checkbox"/> Customize

GSTD1050PJ-SERIES-AE

Current Characteristic:

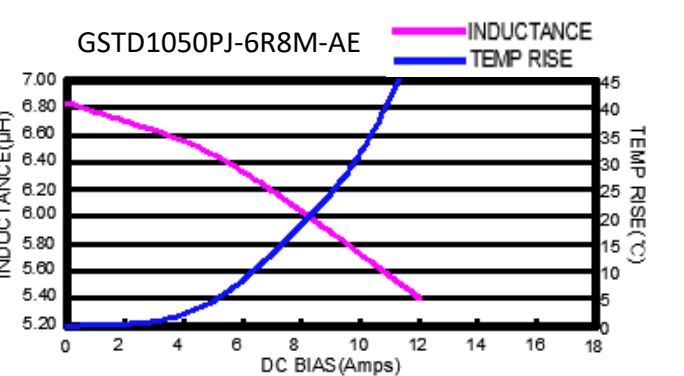
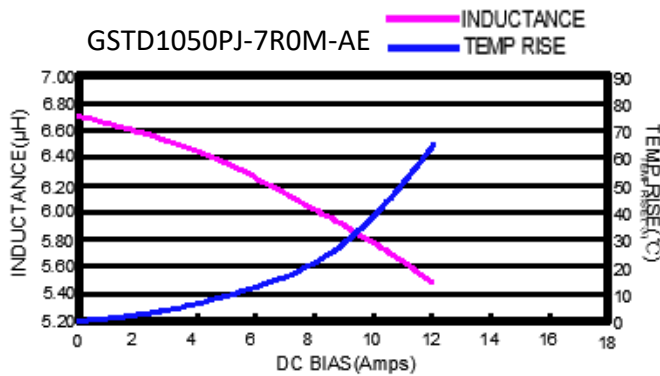
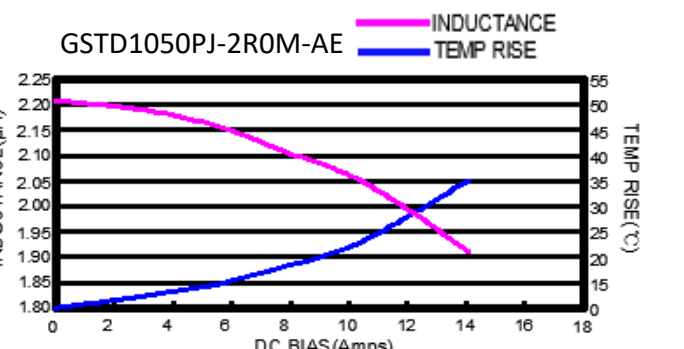
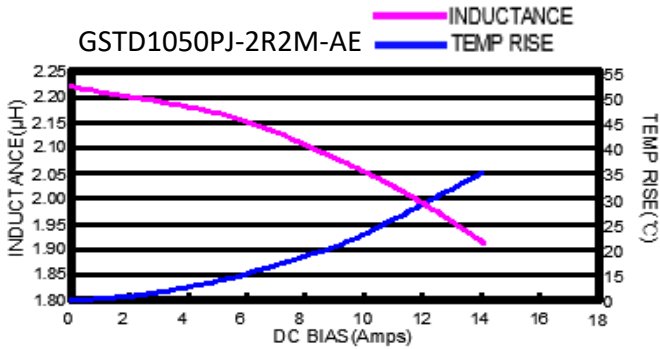
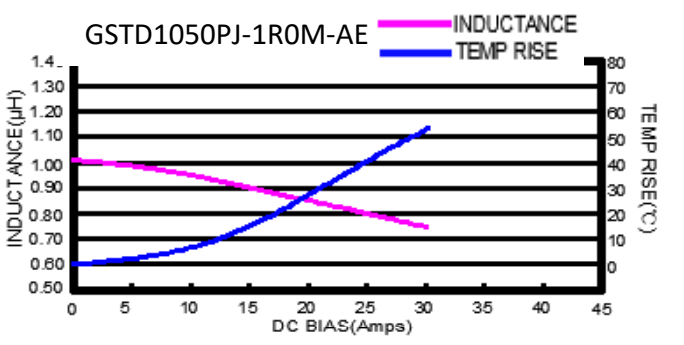
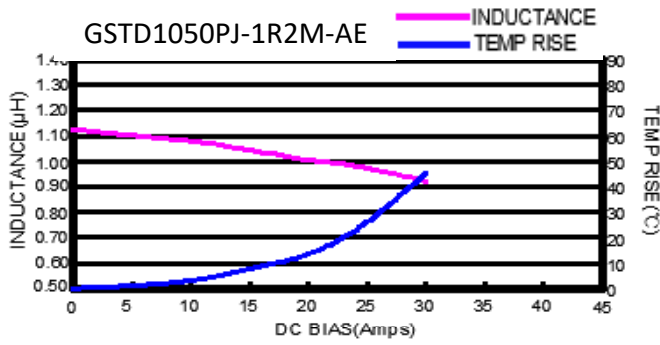
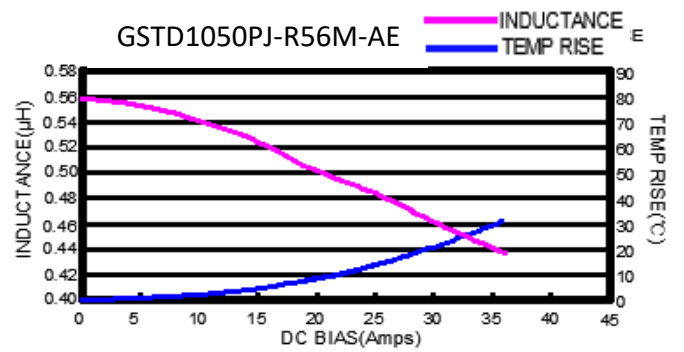
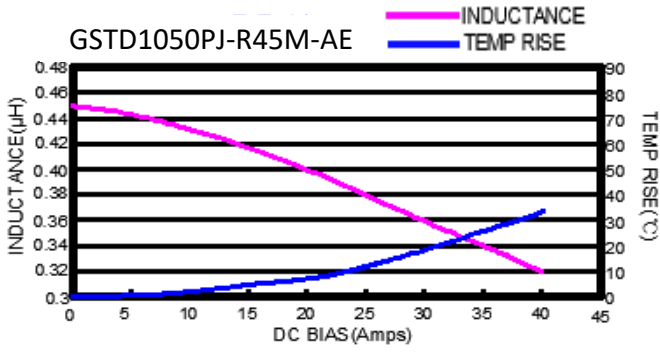

Product Series : GSTD	Brand : GOTREND
File Version : GSTD-PJ-SERIES-AE-V1R0	Editor : Qiuyi Wu
Established Date : 2023.11.20	Description : High Current Inductor
Latest Edit Date : 2023.11.20	Product Type : <input checked="" type="checkbox"/> Standard <input type="checkbox"/> Customize

GSTD1050PJ-SERIES-AE

Current Characteristic:

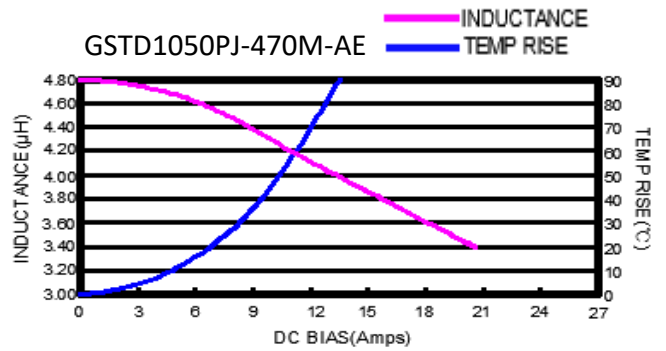
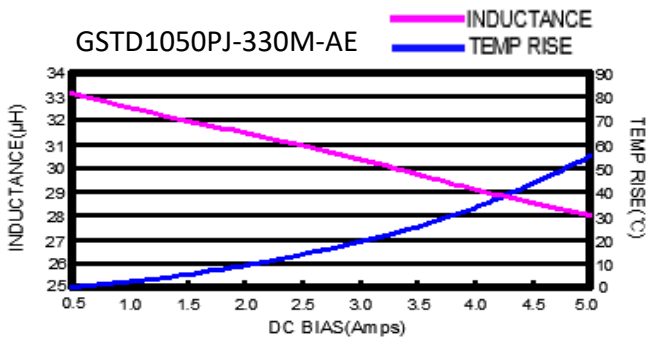
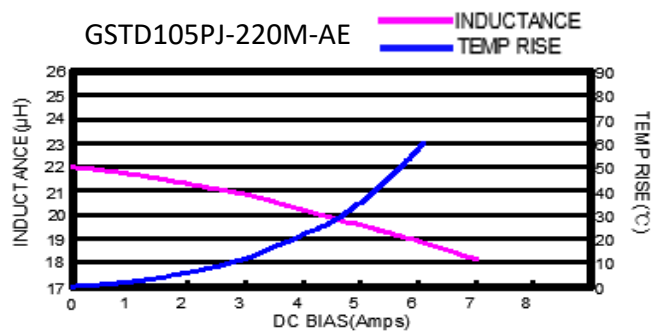
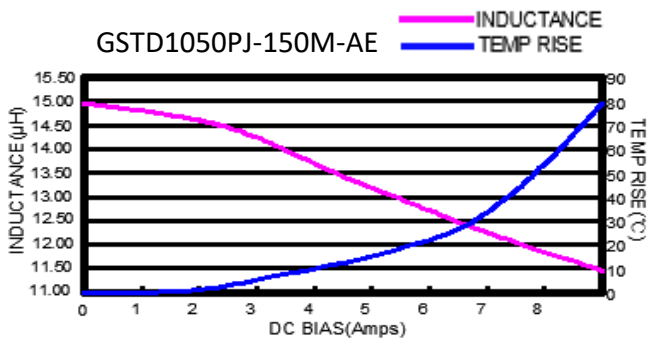
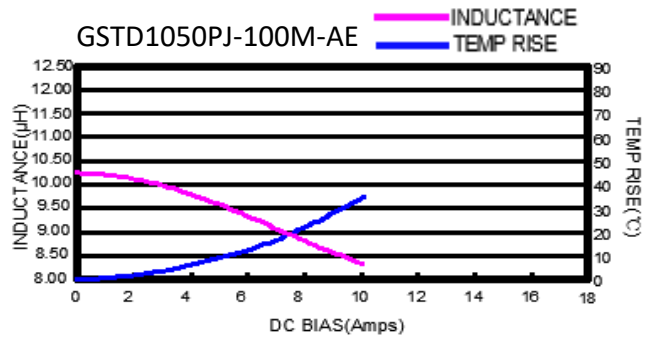
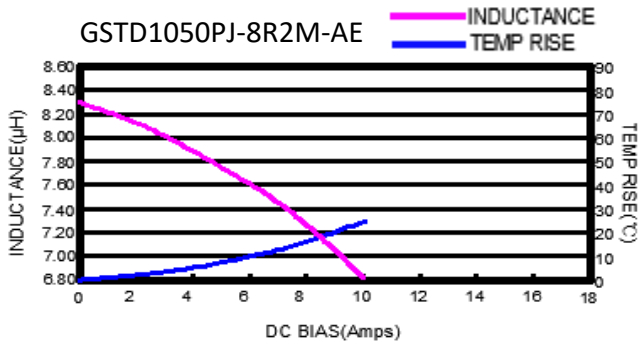

Product Series : GSTD	Brand : GOTREND
File Version : GSTD-PJ-SERIES-AE-V1R0	Editor : Qiuyi Wu
Established Date : 2023.11.20	Description : High Current Inductor
Latest Edit Date : 2023.11.20	Product Type : <input checked="" type="checkbox"/> Standard <input type="checkbox"/> Customize

Care note :

Care note for Use :

(1) Storage Condition :

Temperature 25 to 35 °C , Humidity 45 to 60% RH

(2) Use Temperature :

- a. Minimum Temperature : -40 °C Ambient temperature of this product.
- b. Maximum Temperature : +125 °C The value of temperature including ambient and temperature rise of this product.
- c. Reliability test temperature range from -40 ~ +125 °C
- d. However, this is not meant as temperature grade guarantee for UL.

(3) Model :

When this product was used in a similar or as new product to the original one, sometimes it might be unable to satisfy the specifications due to difference in condition of usage.

(4) Drop :

If this product suffered mechanical stress such as drop, characteristics may become poor (due to damage on coil / bobbin / ferrite ... etc.)

Never use such stressed product.

Care note for Safety :

(1) Provision to Abnormal Condition :

This product itself does not have any protective function in abnormal condition such as overload, short-circuit and open-circuit conditions, etc.

Therefore, it shall be confirmed from the end product that there is no risk of smoking, fire, dielectric withstand voltage insulation resistance, etc. in abnormal conditions to provide protective devices and /or protection circuit in the end product.

(2) Temperature Rise :

Temperature rise on this product depends on the installation condition on end products.

It shall be confirmed on the actual end product that temperature rise of this product is within the specified temperature class limit.

(3) Dielectric Strength :

Dielectric withstanding test with higher voltage than specific value will damage insulating material and shorten its life.

(4) Water :

This product must not be used in wet condition resulted from water, coffee or any liquid contact because insulation strength becomes very low under such condition.

(5) Potting :

If this product is potted in some compound, coating material of magnet wire might be occasionally damaged. Please ask us if you intend to pot this product.

(6) Detergent :

Please consult our company immediately once under such circumstances because product reliability confirmation etc. is needed when this product come in contact with these chemicals.

Product Series : GSTD	Brand : GOTREND
File Version : GSTD-PJ-SERIES-AE-V1R0	Editor : Qiuyi Wu
Established Date : 2023.11.20	Description : High Current Inductor
Latest Edit Date : 2023.11.20	Product Type : <input checked="" type="checkbox"/> Standard <input type="checkbox"/> Customize

Reliability for automotive products :

No	Item	Test Conditions	Specification
1	External Visual MIL-STD-883 Method 2009	Inspect device construction and workmanship. Electrical test not required.	There is no change for appearance (electrode did not fall off , loose , no breakage , ferrite core did not break , damage)
2	Physical Dimension JESD22 Method JB-100	Verify physical dimensions to the device specification.	For Spec.
3	Thermal Shock MIL-STD-202 Method 107	Temperature : -40 ± 2 °C ~ $+125\pm 2$ °C Max transfer time : 20 s. Dwell time : 15 minutes. Air - Air	There is no change for appearance (electrode did not fall off , loose , no breakage , ferrite core did not break , damage) Inductor value / resistance change rate $\pm 10\%$.
4	Humidity Resistance MIL-STD-202 Method 103	Humidity : 85% RH Temperature : 85 °C Test time : 1000 Hours	There is no change for appearance (electrode did not fall off , loose , no breakage , ferrite core did not break , damage) Inductor value / resistance change rate $\pm 10\%$.
5	High Temperature MIL-STD-202 Method 108	Temperature : 125 ± 2 °C Test time : 1000 Hours	There is no change for appearance (electrode did not fall off , loose , no breakage , ferrite core did not break , damage) Inductor value / resistance change rate $\pm 10\%$.
6	Temperature and Humidity Cycle JESD22 Method JA-104	Temperature : -40 °C ~ $+125$ °C Cycles : 1000	There is no change for appearance (electrode did not fall off , loose , no breakage , ferrite core did not break , damage) Inductor value / resistance change rate $\pm 10\%$.
7	Operational Life MIL-PRF-27	Temperature : 125 °C Load : Allowed DC current Test time : 1000 Hours	No short circuit , open circuit.
8	Vibration MIL-STD-202 Method 204	5 g's for 20 minutes , 12 cycles each of 3 orientations. Test from 10Hz ~ 2000Hz	No bad phenomenon.
9	Mechanical Shock MIL-STD-202 Method 213	Figure 1 of Method 213 SMD : Condition C.	No bad phenomenon.
10	Resistance to Soldering Head MIL-STD-202 Method 210	Condition B No pre-heat of samples. Temperature 250 up / 5 s. Temperature 183 up / 90 ~ 120 s.	Tin solder have to cover over 90% area.
11	Solderability J-STD-002	a. Method B , 4 Hours @ 155 °C dry heat @ 235 °C b. Method B @ 215 °C category 3 c. Method D @ 260 °C category 3	No change and transform form the appearance.

Product Series : GSTD	Brand : GOTREND
File Version : GSTD-PJ-SERIES-AE-V1R0	Editor : Qiuyi Wu
Established Date : 2023.11.20	Description : High Current Inductor
Latest Edit Date : 2023.11.20	Product Type : <input checked="" type="checkbox"/> Standard <input type="checkbox"/> Customize

Packaging Information :

Tape Dimension (mm)

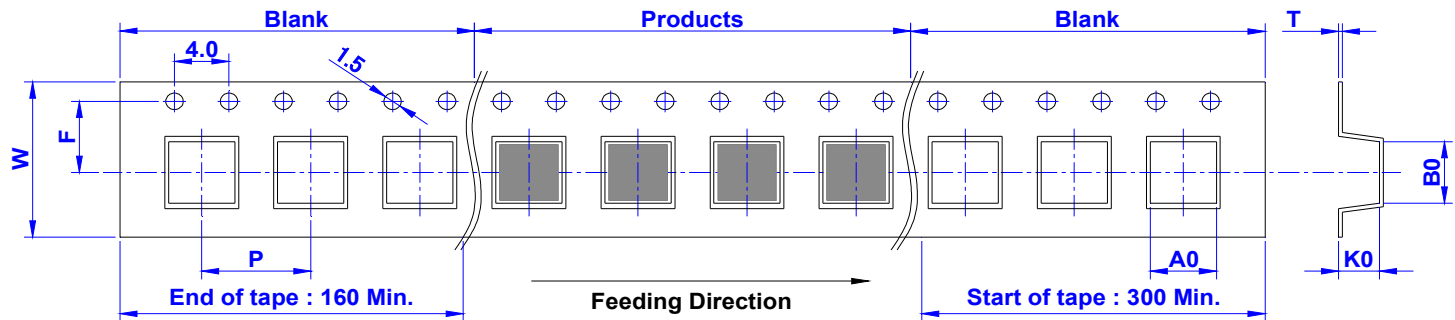

SIZE/mm	W	P	A0	B0	K0	T	F
4012PJ	12.00	8.00	4.20	4.60	1.70	0.30	5.50
4015PJ	12.00	8.00	4.20	4.60	1.70	0.30	5.50
4020PJ	12.00	8.00	4.20	4.60	2.50	0.30	5.50
6040PJ	16.00	12.00	6.70	7.60	4.60	0.30	7.50
1050PJ	24.00	16.00	10.25	12.30	5.80	0.30	11.50

Reel Dimension (mm)

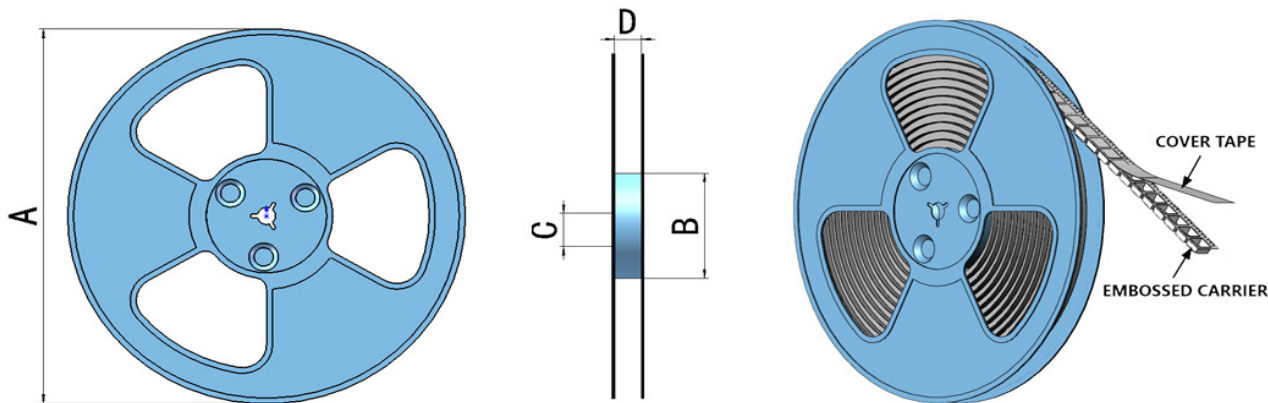

SIZE/mm	Reel Size	A	B	C	D	QTY / Reel
4012PJ	13" x 12 mm	330	100	13	12.6	2000 PCS
4015PJ	13" x 12 mm	330	100	13	12.6	2000 PCS
4020PJ	13" x 12 mm	330	100	13	12.6	2000 PCS
6040PJ	13" x 16 mm	330	100	13	16.5	1000 PCS
1050PJ	13" x 24 mm	330	100	13	24.5	700 PCS

Tearing Off Force

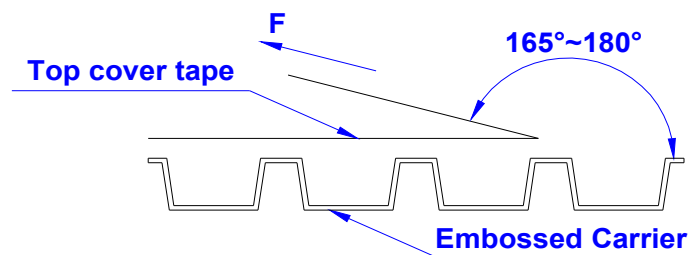

The force for tearing off cover tape is 10 to 130 grams in the arrow direction under the following conditions (referenced ANSI / EIA - 481 - D - 2008 of 4.11 standard).

Room Temp. (°C)	Room Humidity (%)	Room Atm. (hPa)	Tearing Speed (mm / min)
5 ~ 35	45 ~ 85	860 ~ 1060	300

Product Series : GSTD	Brand : GOTREND
File Version : GSTD-PJ-SERIES-AE-V1R0	Editor : Qiuyi Wu
Established Date : 2023.11.20	Description : High Current Inductor
Latest Edit Date : 2023.11.20	Product Type : <input checked="" type="checkbox"/> Standard <input type="checkbox"/> Customize

Packaging Information :

Box Package

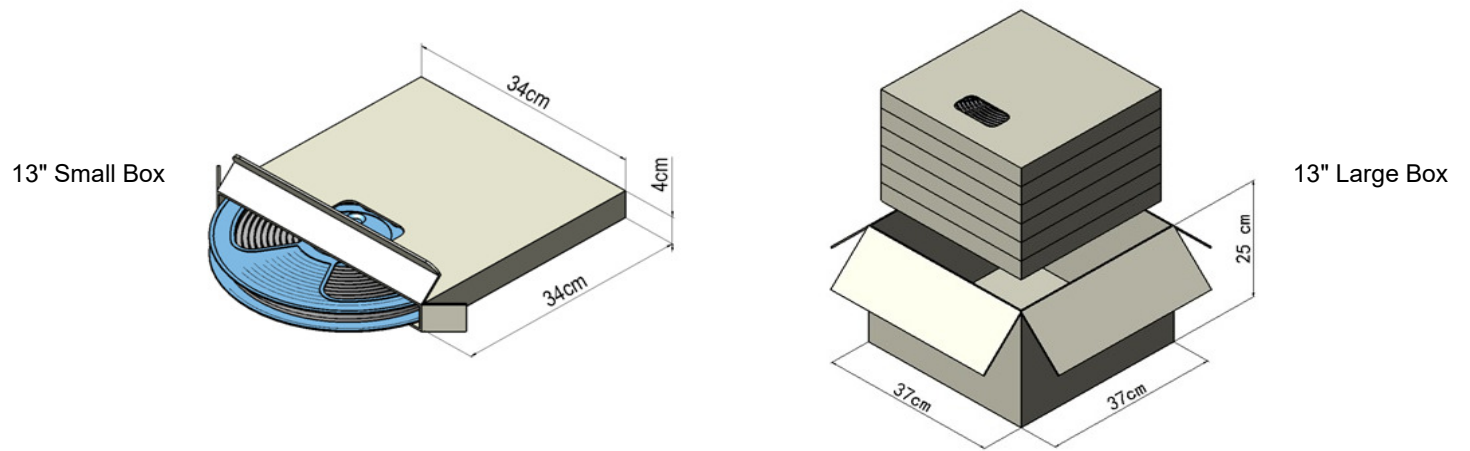

SIZE/mm	Reels in Small Box(QTY)	Small Box in Large Box(QTY)
4012PJ	2	5
4015PJ	2	5
4020PJ	2	5
6040PJ	1	5
1050PJ	1	5